

MERIDIAN

TEMPERATURE SCREENING KIOSKS

Designed to provide a temperature verification and facial recognition solution, Meridian's Personnel Management Kiosk includes a DVITEC dual lens 2MP B/W & 2MP WDR USB camera module.

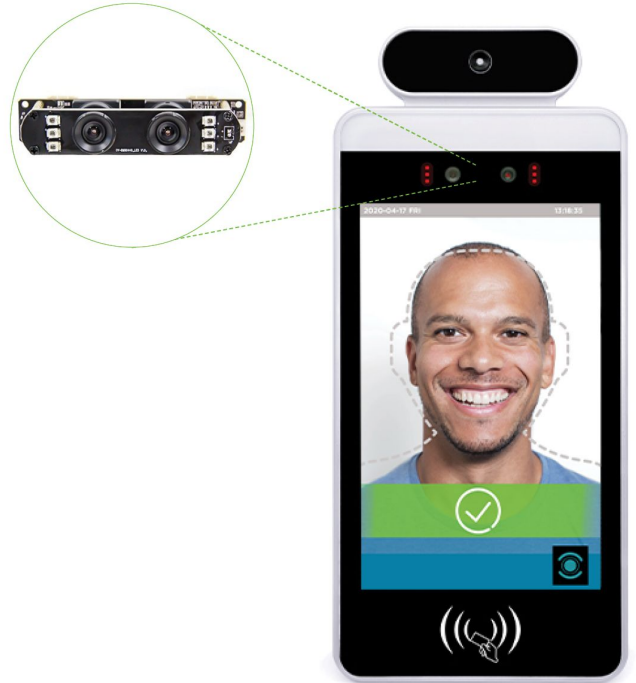

CAMERA FEATURES

- 1 / 2.7" 2 Mega High Sensitive CMOS Sensor
- 30 FPS High Rate
- 0.01 Lux Super Low Lux
- -22°F-158°F Wide Working Temperature
- USB 2.0 High Speed
- UVC Structure

SPECIFICATIONS

SIGNAL	2M B/W	2M WDR
Scanning System	Progressive Scan	
Scanning Frequency (H)	30HZ	25HZ
Scanning Frequency (V)	59.9HZ	50HZ
Image Sensor	1 / 2.7" CMOS	1 / 2.7" CMOS
Effective Pixels	1920 x 1080	1920 x 1080
Pixel Size	3.0um x 3.0um	3.0um x 3.0um
Image Sensor Data Output	Raw Data 10 bits	Raw Data 10 bits
Video Compressor	MJPEG / YUY2	MJPEG / YUY2

SIGNAL	2M B/W	2M WDR
Maximum Frame Rates	1920 x 1080 at 30 fps 1280 x 1024 at 30 fps 1280 x 720 at 30 fps 1024 x 768 at 30 fps 960 x 540 at 30 fps 800 x 600 at 30 fps 640 x 480 at 30 fps 352 x 288 at 30 fps 320 x 240 at 30 fps 160 x 120 at 30 fps	1920 x 1080 at 30 fps 1280 x 960 at 30 fps 1280 x 720 at 30 fps 1024 x 768 at 30 fps 960 x 540 at 30 fps 800 x 600 at 30 fps 640 x 480 at 30 fps 352 x 288 at 30 fps 320 x 240 at 30 fps 160 x 120 at 30 fps
Maximum Frame Rates	1920 x 1080 at 5 fps 1280 x 1024 at 5 fps 1280 x 720 at 10 fps 1024 x 768 at 10 fps 960 x 540 at 15 fps 800 x 600 at 20 fps 640 x 480 at 30 fps 352 x 288 at 30 fps 320 x 240 at 30 fps 160 x 120 at 30 fps	1920 x 1080 at 5 fps 1280 x 960 at 5 fps 1280 x 720 at 10 fps 1024 x 768 at 10 fps 960 x 540 at 15 fps 800 x 600 at 20 fps 640 x 480 at 30 fps 352 x 288 at 30 fps 320 x 240 at 30 fps 160 x 120 at 30 fps
SNR Max	41dB	41dB
Dynamic Range	96dB	105dB
Min. Illumination	0.01LUX at F1.2	0.01LUX at F1.2
Digital Interface	5-pin 1.25mm USB2.0	5-pin 1.25mm USB2.0
Transfer Rates	480MB/S	480MB/S
Power Requirements	5V ± 5%	
Power Consumption	NO LED: Max 0.9W	Max 2.05W
	LED: Max 1.5W	
Dimensions (PCBA) mm	80 x 16mm	
Operating Temperature (°F)	-22°F – 158°F	
Storage Temperature (°F)	-40°F – 176°F	
Compliance	USB-IF WHQL CE RoHS	

SENSOR DIMENSION & FILTER WAVELENGTH

SENSOR DIMENSION

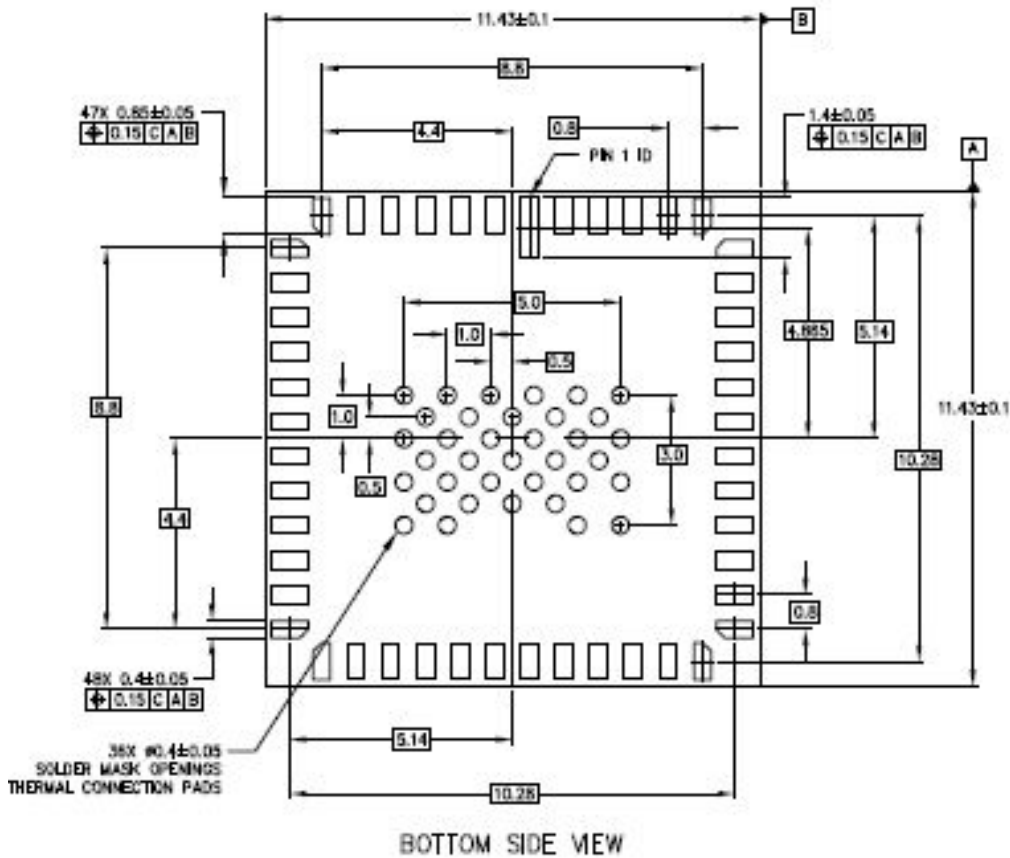

IR-FILTER WAVELENGTH

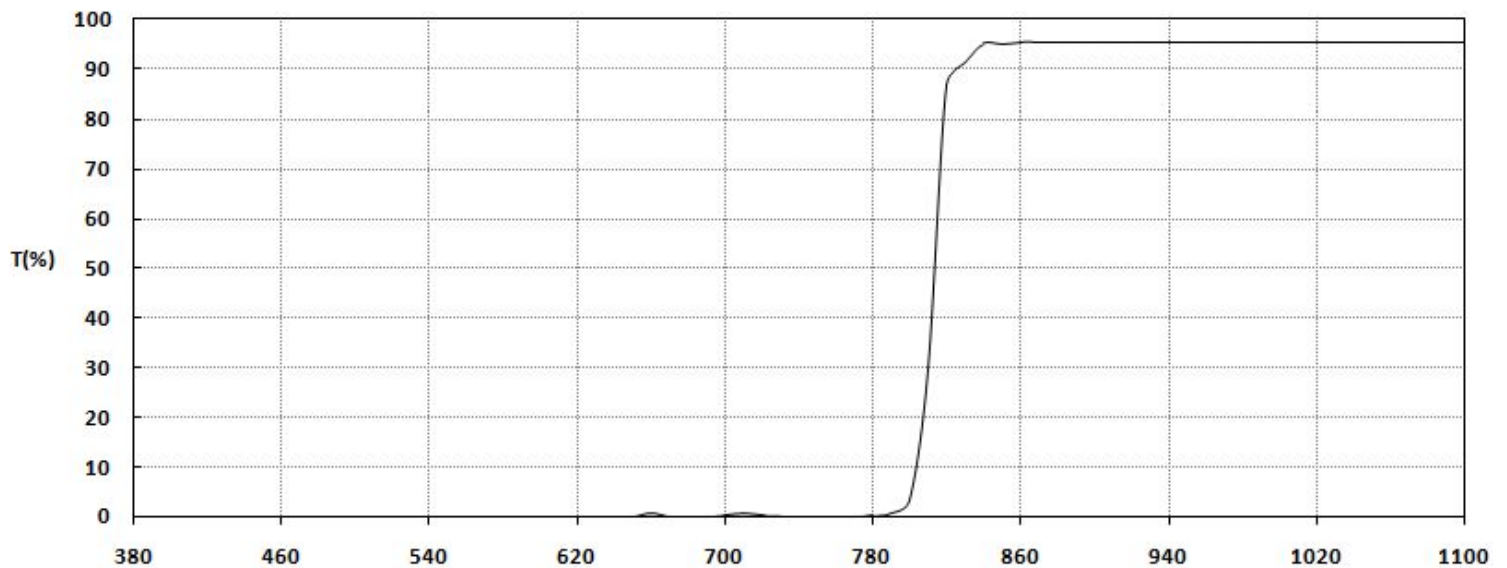

SENSOR DIMENSION

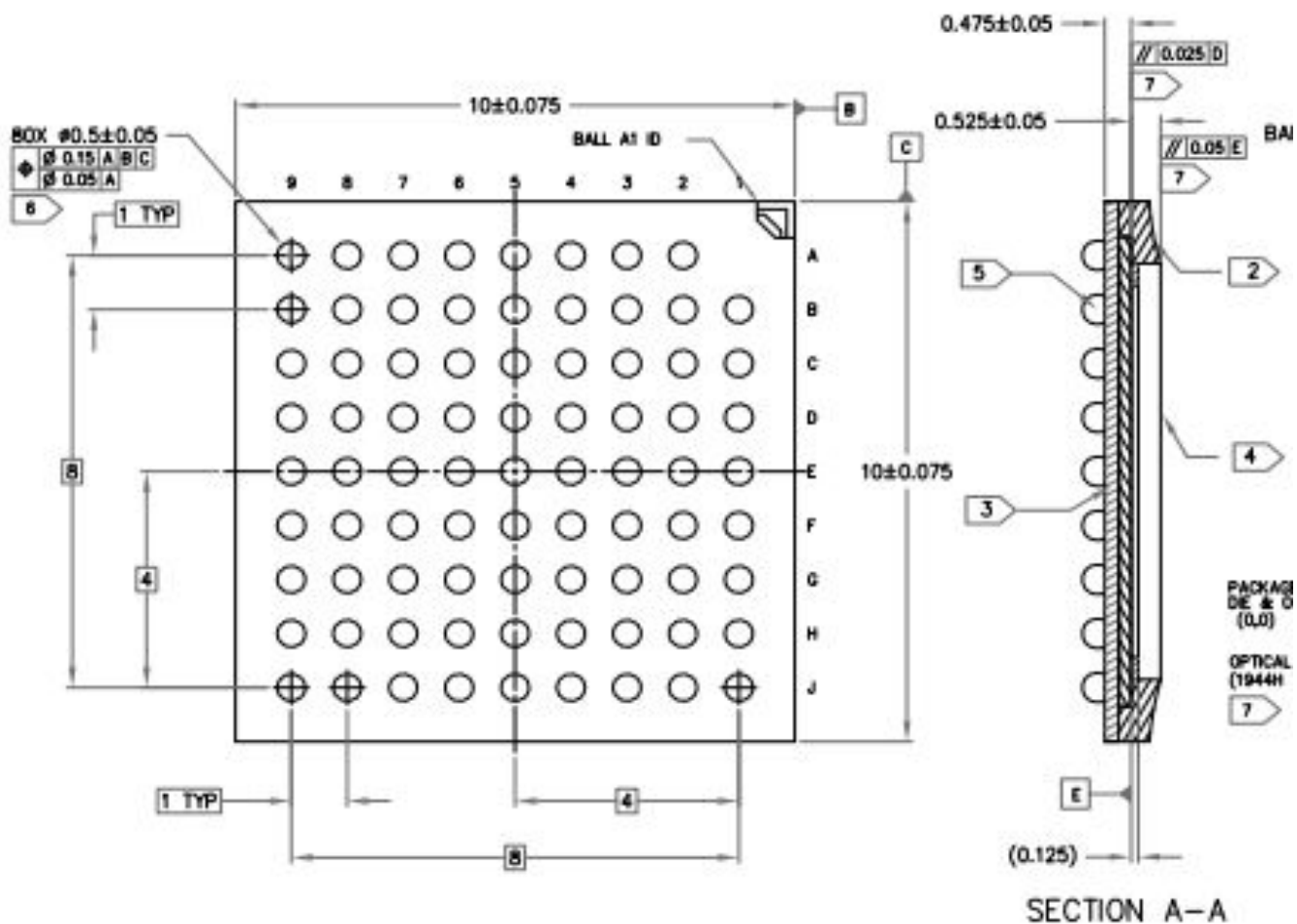

COLOR-IR FILTER WAVELENGTH

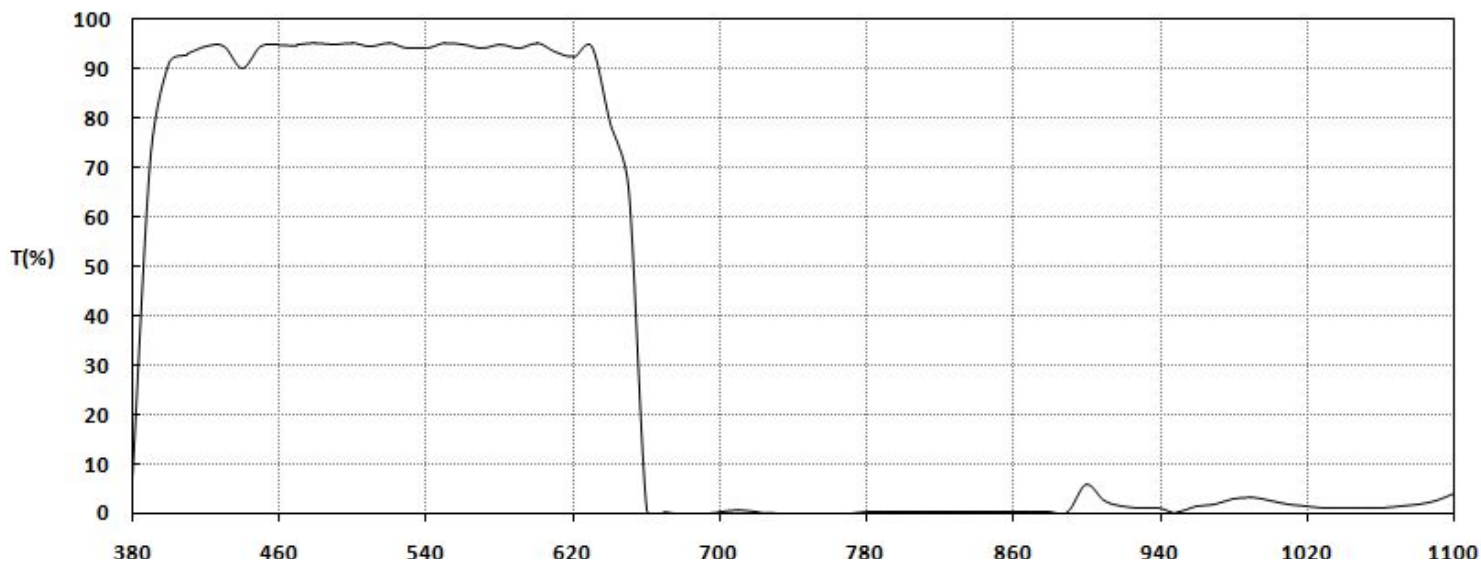

PRODUCT DIMENSIONS

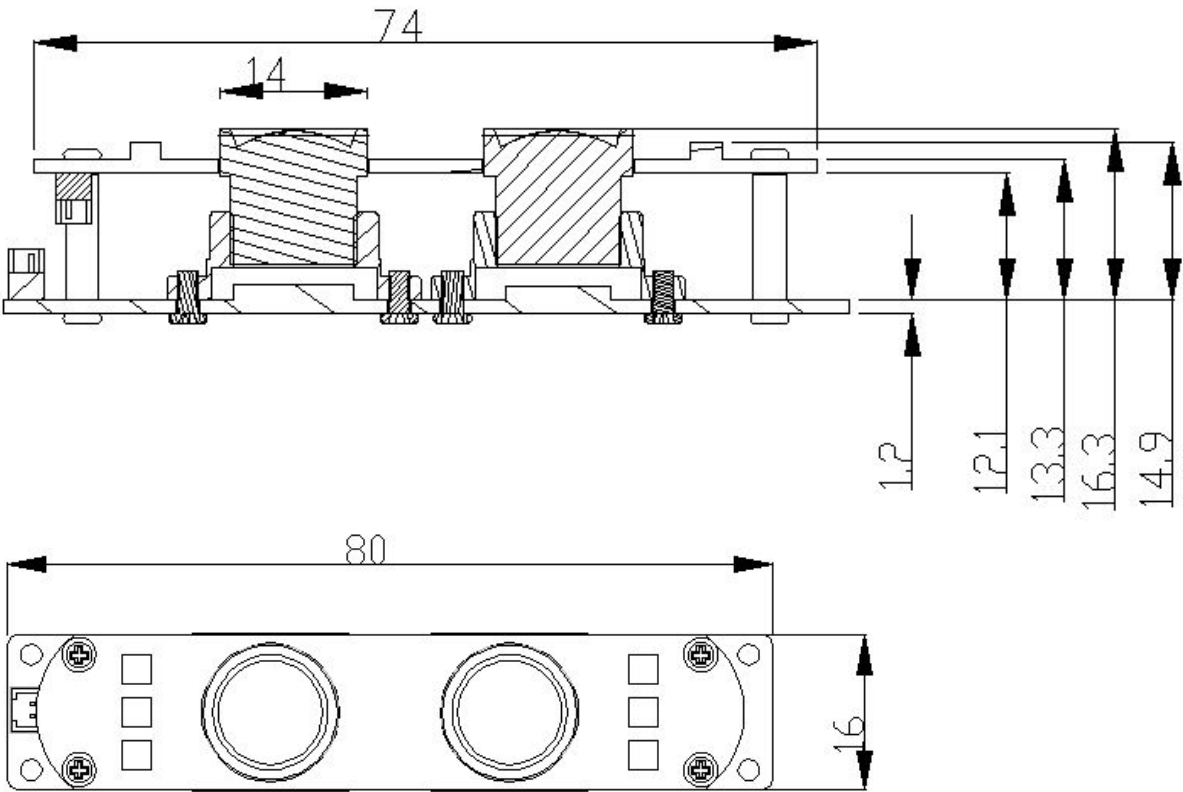

VIEWING ANGLE

COLOR



BLACK & WHITE

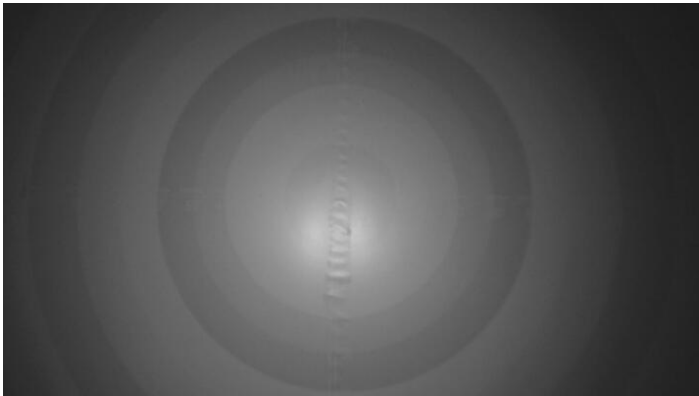

COVER PROPORTION (mm)

NO.	COMPONENT	PROPORTION
1	ZN	96.2000%
2	CU	0.0160%
3	Aluminum	3.7000%
4	Fe	0.0030%
5	Pb	0.0025%
6	Sn	0.0004%
7	Mg	0.0030%



CORPORATE HEADQUARTERS
312 S Pine Street, Aberdeen, NC
sales@mzero.com
+ 1 866 454 6757

SOFTWARE DEVELOPMENT LAB
30 Eglinton Ave, Ste 808, Mississauga, Ontario, Canada

Component specifications subject to change without notice. Revision Date: October 6, 2020

This device is not FDA-cleared or approved. This temperature device should not be solely or primarily relied upon to diagnose or exclude a diagnosis of COVID-19, or any other disease or health condition. Elevated body temperature in the context of use should be confirmed with secondary evaluation methods, such as a non-contact infrared thermometer or clinical grade contact thermometer.

